

GROOVED PINS

Why Use Grooved Pins ?

Simple Hole Preparation

Resistance To Shock And Vibration

Total Range

They Are Reusable

Simple Installation

Strength

- No reaming or threading of the hole prior to installation is required
- Because the pin is held in position under elastic tension it cannot easily be dislodged in harsh environments.
- Standard pin types are available for many applications eliminating the need for more labour intensive or complex fasteners, or custom designed expensive parts.
- When removed from the application the grooves recover their form and can be reused many times with only minimal reduction in pull out performance.
- Providing correct procedures are followed (see below) there is no need for special installation equipment for small volumes. Where high production quantities are anticipated the pin can easily be fed and does not require sophisticated installation equipment.
- The Tappex Grooved Pin is a solid steel fastener giving high shear strength and good wear resistance.

Installation Information

Hole Preparation

- When drilling the hole for installation of a grooved pin a standard twist drill should be used of the same nominal diameter as the ungrooved pin. Hole tolerance H9 for pins under 3mm and H11 for 3mm and above although in steel a slightly larger hole will only marginally affect withdrawal loads. Tappex Grooved Pins are produced with a minus tolerance on the ungrooved diameter to allow an easy fit.

Pin Strength

- The tensile strength of the pin must be the same as or higher than the strength of the component material.

Installation

- Parallel groove pins require significantly higher installation forces than tapered groove pins. To eliminate the chance of any difficulty during installation a 60° counter sink should be incorporated into the hole and the pin should be slightly lubricated prior to installation. During installation it is important to ensure correct alignment between the pin and the hole.

Installation Forces

These figures give data on average installation forces required for tapered and parallel grooves.

Generally the force to remove a pin is slightly more than the force required to install it.

Tapered Grooves - insertion force in kgs per length of groove.

Nom. dia. mm.	1.5	2	2.5	3	4	5	6	8
6mm	23	30	37	64	95	132	223	
12mm	50	64	82	128	186	255	418	609
18mm	73	91	123	186	273	368	600	664
24mm	94	128	164	255	364	482	770	1118
36mm					523	686	1064	1518
48mm					682	891	1345	1918
60mm								2395
72mm								2864

Parallel Grooves - insertion force per mm of groove

kgs.	9	11	13	17	22	28	40	55
------	---	----	----	----	----	----	----	----

Product Identification

The part number is made up of the nominal diameter and effective length. The example shown here is for Grooved Pin S8 - third length centre tapering grooves - DIN 1475. A standard part number assumes a plain steel material. Other materials should be noted at the time of specifying by quoting the appropriate material reference (see page 7).

058 3 x 25
 Product Type (i.e. Grooved Pin S8) diameter (d₁ = 3mm) length (l = 25mm)

Grooved Pins

Standard Types

Grooved Pin S1

Full length tapering grooves
DIN 1471
Part Number **055**
Page 8



- Original replacement for a conventional taper pin eliminating reaming of drilled holes thereby reducing machining time.
- Tapered grooves allow easy progressive installation.
- Used as a locking pin, fixing pin or connecting pin.

Grooved Pin S2

Half length tapering grooves
DIN 1472
Part Number **056**
Page 9

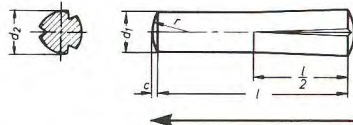

- Plain portion over half length serves as free moving hinge pin for application as a dowel pin or linkage bolt; axle or bearing pin.
- Half tapered grooves ease assembly in through drilled holes.

Grooved Pin S3

Full length parallel grooves
DIN 1473
Part Number **059**
Page 10

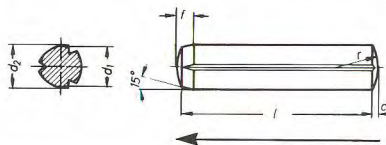

- Maximum retention over whole length produced by full length parallel grooves.
- Suitable for applications involving longitudinal stress and vibration.
- Replaces type **055** where improved performance is required.

Grooved Pin S4

Half length reverse tapering grooves
DIN 1474
Part Number **057**
Page 11

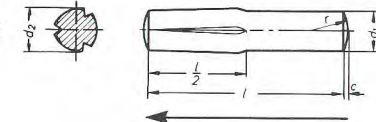

- Reverse taper groove eases installation into blind drilled holes.
- Half length plain portion can be used as a drive element stop pin or bearing.
- Plain portion can also be used as a handle replacing an expensive threaded component.

Grooved Pin S5

Full length parallel grooves
plain spigot one end DIN 1470
Part Number **100**
Page 12

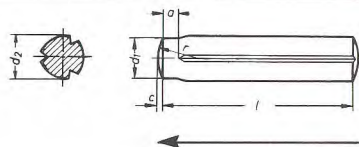

- Plain spigot on one end of pin allows the fastener to be easily located in the drilled hole before assembly.
- Maximum retention from parallel grooves.
- Plain spigot length can be increased for special applications.
- Applications as for **059**.

Grooved Pin S6

Half length tapering grooves
annular ring
Part Number **062**
Page 13

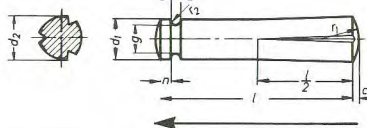

- Combination of tapered grooves and annular ring provides a dual purpose pin fastener.
- For use in drilled through holes.
- For applications where reciprocating springs, circlips or retainers need to be used.

Grooved Pin S7

Half length reverse tapering grooves
annular ring
Part Number **061**
Page 14

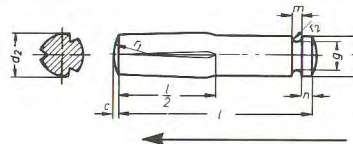

- Reverse taper grooves are designed for installation into blind holes.
- Annular ring acts as circlip groove, etc., as for **062**.

Grooved pin S8

Third length centre tapering grooves
DIN 1475
Part Number **058**
Page 15

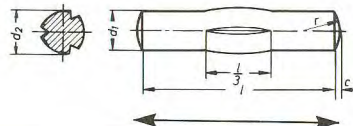

- Tapering groove design gives easy installation either way.
- Cental location allows the pin to be used as a cross handle, hinge pin or fulcrum bolt.
- A plain portion at each end gives a free fit for mating components.
- Length of grooved section can be increased or decreased to suit applications.

Grooved Pin S9

Full length tapering grooves
annular ring
Part Number **101**
Page 16

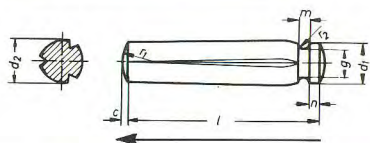

- The combination of a full length tapering groove for ease of installation and an annular ring at one end makes this pin highly suitable for repeated removal.
- The annular ring makes it possible to attach a device for simple removal of the pin.
- For applications as a locking pin or fixing pin in blind holes.

← Direction of Installation

Many of the above parts with DIN number references, can now be supplied to the EN ISO equivalent, where the stated length is specified over the ends of the pin. Please ask for details.

Grooved Pins

Standard Types

Grooved Pin S10

Third length tapering grooves
two annular rings
Part Number **102**
Page 17

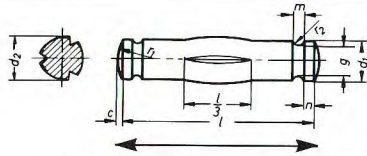

- Central tapering grooves for ease of installation.
- Two annular rings for reciprocating springs or as a fixed axle in conjunction with retaining rings or circlips.

Grooved Pin S11

Third length reverse tapering grooves
Part Number **103**
Page 18

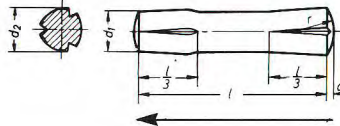

- In applications where only one direction of assembly is possible (e.g. where one component incorporates a blind hole) double tapering grooves in one direction ease installation.
- Central plain portion for free fit of a moving component.
- For use as an axle, pulley or lever.

Grooved Pin S12

Third length reverse tapering grooves
Part Number **060**
Page 19

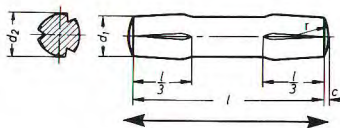

- In applications where access to either side of the assembly is possible, grooves tapering at each end ease assembly.
- Central plain portion available as for **103**.

Grooved Pin S24

Half length parallel grooves
Part Number **104**
Page 20

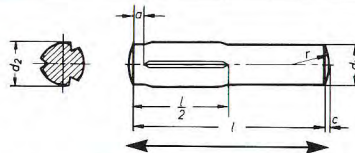

- A parallel groove over half the length of the pin significantly increases resistance to withdrawal in arduous applications (e.g. shock and vibration).
- Plain spigot on grooved end allows location in hole before assembly.
- Hole preparation recommendations should be followed closely.
- Can be used as alternative to **056** or **057** pins where necessary.

Grooved Pin S30

Full length parallel grooves
double chamfer
Part Number **105**
Page 21

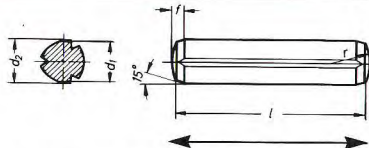

- For applications for **059** pins where the use of semi automatic or automatic installation equipment is required due to high volume.
- A double chamfer is provided to simplify bowl feeding.
- Can be used in lower volume applications for double ended entry.

Grooved Pin S50

Full length parallel grooves
double spigot
Part Number **106**
Page 22

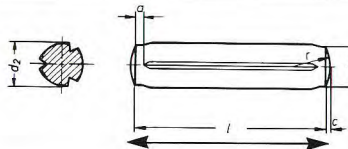

- A plain spigot at each end of the pin allows location in the component before assembly but removes problem of orientation of the fastener.
- Suitable for automatic assembly as for type **105**.

Grooved Pin S67

Half length parallel grooves
annular ring DIN 1469
Part Number **107**
Page 23

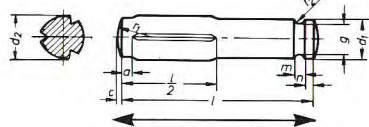

- The use of a parallel groove improves pin retention.
- Should be used to replace **061** or **062** in applications where high vibration or shock loading may occur.
- Plain spigot on grooved end allows location prior to assembly.

Grooved Pin S80

Third length parallel grooves
Part Number **108**
Page 24

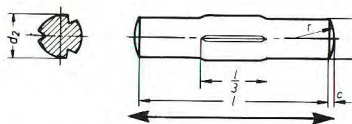

- The use of a parallel groove improves pin retention.
- Should be used to replace **058** pins in applications where high vibration or shock loading may occur.
- Use where shorter groove lengths are required.

Grooved Pin S112

Third length double parallel grooves
Part Number **109**
Page 25

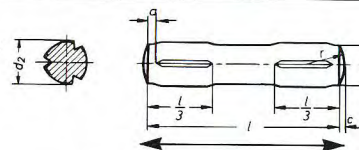

- The use of a parallel groove improves pin retention.
- Should be used to replace **060** and **103** in applications where high vibration or shock loading may occur.
- Plain spigot on each end allows location prior to assembly.
- Pin can be installed from either direction in blind or through holes.
- Use where shorter groove lengths are required.

← Direction of Installation

Headed Grooved Pins

Standard Types

Headed Grooved Pin N4

Round Head Drive Pin DIN 1476
Part Number **063**
Page 26

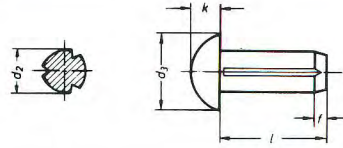

- Combining the grooved pin principle with a headed stud makes it possible to use the fastening method for the retention of items in an assembly.
- Parallel grooves give maximum retention.
- For fixing name plates, panels, linings, pipe clips or any additional component to an assembly.
- Very rapid installation time shows a cost saving over conventional screws.

Headed Grooved Pin N5

Countersunk Head Drive Pin DIN 1477
Part Number **064**
Page 27

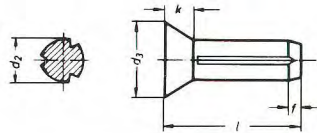

- Similar applications to pin **063** but with a countersunk head.
- For applications where a flush fit is necessary.
- Increased groove length will give increased retention where the application allows.

Headed Groove Pin N7

Round Head Drive- plain shank
Part Number **110**
Page 28

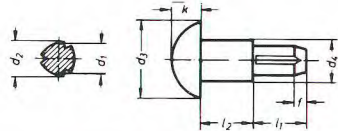

- This pin again demonstrates the flexibility of the grooved pin system.
- A pin can be produced which gives retention, rapid assembly and has a plain shank to allow free movement of mating components.
- Can be used as a bearing pin for catches, sashes, hooks etc.

Blind Drive Pin Rivets

Standard Types

Blind Drive Pin Rivet B60

Round Head Din 660
Part Numbers **019 or 020**
Page 29

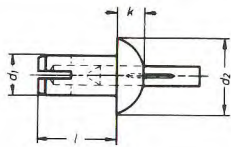

- Simple setting operation permits use in a wide range of factory and field applications.
- Simple setting and rivet configuration make it easy to automate.
- Clamping lengths can be varied to allow free movement of assembled parts.
- The blind drive pin rivet can be used for fixing metal strips to wooden panels, for fixing frames to hollow sections or for clamping various thicknesses of metals.

Blind Drive Pin Rivet B61

Countersunk Head Din 661
Part Numbers **021 or 022**
Page 30

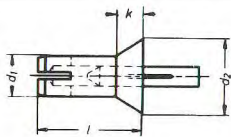

- Countersunk version of the drive pin rivet for flush fitting applications in sheet metal and wood.
- Clamping length includes the countersunk depth.
- For attaching name plates, tags or metal strips to wood or metal.

Blind Drive Pin Rivet B74

Flat-Round Head DIN 674
Part Numbers **111 or 112**
Page 31

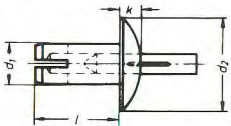

- A larger diameter head type allows the use of the blind drive pin rivet in softer materials.
- A flatter head thickness can sometimes be used where there is a space restriction.
- For attaching insulation materials to framework or for other soft materials.

Standard Tolerances

Body diameter, dome and length

The Grooved Pin designs are subject to certain standard tolerances which are listed here. Other specific tolerance information is provided on the relevant product page.

Tolerance on body diameter and dome

Nominal d,	1.5	2	2.5	3	4	5	6	8	10	12	(13)	14	16	20	25
d, tolerances	+0.0 -0.025			+0.0 -0.075			+0.0 -0.090			+0.0 -0.110			+0.0 -0.130		
c max.	.23	.3	.4	.45	.6	.75	.9	1.2	1.5	1.8		2	2.5	3	4

Tolerance on length 'l'

1mm	-	3mm	±	0.200
over 3mm	-	6mm	±	0.240
over 6mm	-	10mm	±	0.290
over 10mm	-	18mm	±	0.350
over 18mm	-	30mm	±	0.420
over 30mm	-	50mm	±	0.500
over 50mm	-	80mm	±	0.600

Material Specifications

*Grooved Pins, Headed Grooved Pins
& Blind Drive Pin Rivets*

The Tappex Grooved Pin system is manufactured in West Germany, consequently material specifications relate to DIN standards. Various options are available and these are given below together with DIN reference numbers where appropriate and the corresponding British Standard number where available.

Various standards of finish are available where applicable.

If more information is required please contact our Technical Sales Department.

Grooved Pins

Materials		Ref	Equivalent	Finishes (where applicable)
Steel	DIN 1651	W.Nr 1.0718 9SMnPb28K	-	Self Colour Oiled Black Finish
Steel - carbon	DIN 1651	W.Nr 1.0727 45 S 20 K	-	Phosphate Phosphate Oiled
Stainless Steel - Ferritic	DIN 17440	W.Nr 1.4104 X12CrMoS17	416 S21	Copper Brass
Stainless Steel - Austenitic	DIN 17440	W.Nr 1.4305 X10CrNiS18 9	303 S31	Nickel Zinc Chromate
Stainless Steel - Austenitic	DIN 17440	W.Nr 1.4571 X6CrNiMoTi17 122	320 S31	Tin
Aluminium	DIN 1747 part 1	W.Nr 3.1645.51 AlCuMgPbF37	-	
Brass	DIN 17672 part 1	W.Nr 2.0371.26 CuZn38Pb1.5F41	-	

Headed Grooved Pins

Steel	DIN 17111	W. Nr 1.0214 QSt 36-3 or W.Nr 1.0122 RQSt 37-2	-	Self Colour Oiled Black Finish Phosphate Phosphate Oiled Copper Brass
Stainless Steel	DIN 17440	W.Nr 1,4303 X5CrNi1812	305 S19	Nickel Zinc Chromate Tin
Aluminium	DIN 1747 part 1	W.Nr 3.0255.30 Al99.5F13	-	
Brass	DIN 17660	W.Nr 2.0321 CuZn37	-	

Blind Drive Pin Rivet

Rivet Body - Steel	DIN 17111	W.Nr 1.0214 QSt 36-3 or W.Nr 1.0122 RQSt 37.2	-	Self Colour Oiled Black Finish Phosphate Phosphate Oiled Copper Brass
Drive Pin - Steel	DIN 1651	W.Nr 1.0718 9SMnPb28K	-	Nickel Zinc Chromate Tin
Rivet Body - Aluminium	DIN 1725	W.Nr 3.2315 AlMgSi1F20	-	

Grooved Pin S1

Full length tapering grooves ...DIN 1471

Part No. 055...



← Direction of Installation

For standard tolerance information see page 6

- d_1 Body diameter
- d_2 Grooved diameter
- l Body length
- $r_1 = d_1$
- c Height of dome

Tolerance on grooved diameter d_2

up to 2mm	+ 0.05
2.5mm - 10mm	± 0.05
over 10mm	± 0.10

Tolerance on drilled hole diameter

under 1.5mm	= H8
1.5mm - 3mm	= H9
over 3mm	= H11

Dimensions in mm Preferred sizes in **bold**

\varnothing d_1	0,8	1	1,2	1,5	2	2,5	3	4	5	6	8	10	12	13	14	16	20	25	
l	d_2^*																		
4																			
5								3,25											
6	0,83	1,05	1,25	1,63															
8					2,70			4,30											
10									5,30										
12							3,30			6,30									
14											8,35								
16			1,60					4,35											
18				2,15								10,40							
20									5,35				12,40						
22						3,25				6,35				13,45					
24					2,65						8,40				14,45				
25																			
26																16,55			
28								4,30				10,45							
30													12,45						
32						3,20			5,30										
35														13,50	14,50				
36										6,30						16,60			
40											8,35								
45												8,35							
50								4,25	5,25			10,40	12,40						
55																	20,60	25,60	
60																			
65										6,25				13,45	14,45				
70											8,30					16,55			
75												10,35							
80													12,30						
90											8,25								
100														13,40	14,40				
110													10,30				16,50		
120																			

Typical Applications

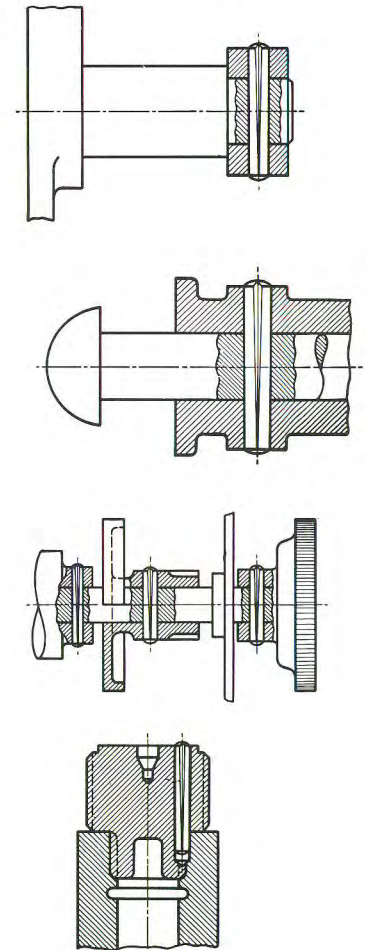

* The grooved diameter d_2 can only be measured with a ring gauge. Grooved diameters stated in the table apply only to material 9SMnPb28K - DIN 1651. The maximum grooved size cannot be achieved with some steels and some non-ferrous metals.

GROOVED PINS

Grooved Pin S2

Half length tapering grooves ...DIN 1472

Part No. 056...

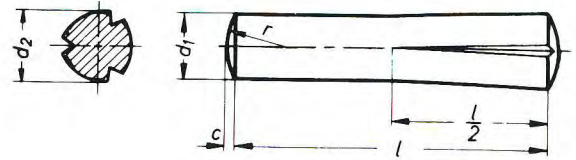

← Direction of Installation

For standard tolerance information see page 6

- d_1 Body diameter
- d_2 Grooved diameter
- l Body length
- $r_1 = d_1$
- c Height of dome

Tolerance on grooved diameter d_2		
up to	2mm	+ 0.05
	2.5mm - 10mm	± 0.05
over	10mm	± 0.10

Tolerance on drilled hole diameter		
under	1.5mm	= H8
	1.5mm - 3mm	= H9
over	3mm	= H11

Dimensions in mm Preferred sizes in **bold**

\varnothing d_1	0,8	1	1,2	1,5	2	2,5	3	4	5	6	8	10	12	13	14	16	20	25	
l	d_2^*																		
4																			
6						2,65	3,20												
8	0,83																		
10								4,25	5,25										
12		1,05	1,25	1,63						6,25									
14							3,25				8,25								
16								4,30				10,30							
18					2,15														
20									5,30							13,30			
22						2,70					8,30		12,30						
24										6,30		10,35							
25							3,30									13,40			
26																	14,40		
28								4,35					12,35						
30											8,35						16,50		
32																			
35									5,35			10,40							
36							3,25						12,40	13,45	14,45		20,50	25,50	
40										6,35						16,55			
45																			
50											8,40								
55								4,30											
60									5,30										
65												10,45	12,45						
70										6,30				13,50	14,55				
75																16,60			
80											8,35								
90																	20,60	25,60	
100												10,40	12,40						
110																			
120														13,45	14,45				
140												10,35				16,55			
160													12,35						
180																			

Typical Applications

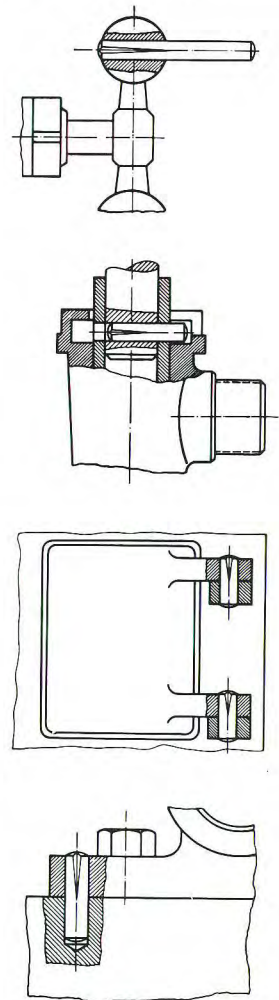

* The grooved diameter d_2 can only be measured with a ring gauge. Grooved diameters stated in the table apply only to material 9SMnPb28K - DIN 1651. The maximum grooved size cannot be achieved with some steels and some non-ferrous metals, particularly in the case of pins with short grooves.

Grooved Pin S3

Full length parallel grooves ...DIN 1473

Part No. 059...

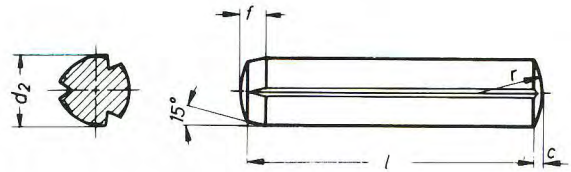

← Direction of Installation

For standard tolerance information see page 6

- d_1 Body diameter
- d_2 Grooved diameter
- l Body length
- $r_1 = d_1$
- c Height of dome
- f Width of chamfer

Tolerance on grooved diameter d_2

up to	2mm	+ 0.05
	2.5mm - 10mm	± 0.05
over	10mm	± 0.10

Tolerance on drilled hole diameter

under	1.5mm	= H8
	1.5mm - 3mm	= H9
over	3mm	= H11

Dimensions in mm Preferred sizes in **bold**

ϕ d_1	0,8	1	1,2	1,5	2	2,5	3	4	5	6	8	10	12	13	14	16	20	25	
$f \approx$	0,55	0,57	0,6	0,8	0,9	1,2	1,3	1,8	2	2,5	2,8	3,5	3,7	3,8	4	4,3	5,2	6	
l	d_2 *																		
4																			
5																			
6	0,83	1,05																	
8			1,25																
10				1,60															
12																			
14					2,15	2,65													
16																			
18																			
20							3,20												
22																			
24																			
25								4,25	5,25										
26																			
28										6,30									
30																			
32											8,30								
35																			
36												10,35							
40													12,35						
45														13,35	14,35				
50																16,40			
55																			
60																	20,50	25,50	
65																			
70																			
75																			
80																			
90																			
100																			
110																			
120																			

Typical Applications

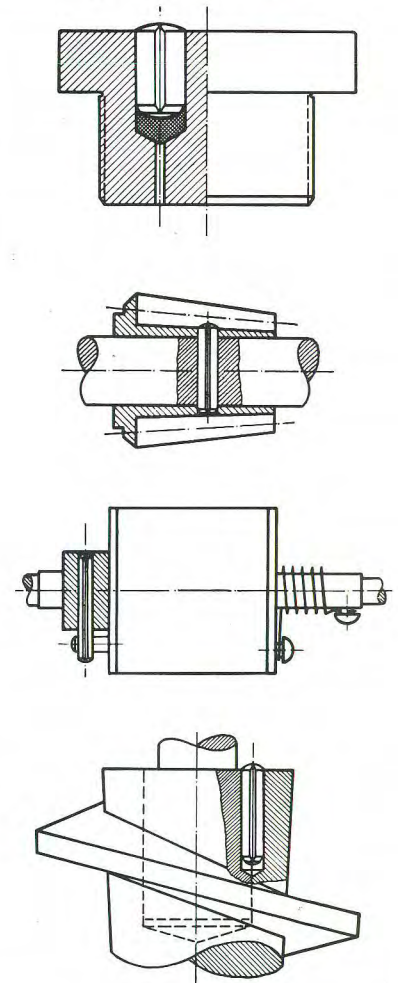

* The grooved diameter d_2 can only be measured with a ring gauge. Grooved diameters stated in the table apply only to material 9SMnPb28K - DIN 1651. The maximum grooved size cannot be achieved with some steels and some non-ferrous metals.

Grooved Pin S4

Half length reverse tapering grooves ...DIN 1474

Part No. 057...

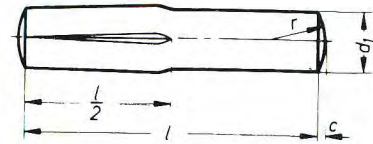

← Direction of Installation

For standard tolerance information see page 6

- d_1 Body diameter
- d_2 Grooved diameter
- l Body length
- $r_1 = d_1$
- c Height of dome

Tolerance on grooved diameter d_2

up to	2mm	+ 0.05
	2.5mm - 10mm	± 0.05
over	10mm	± 0.10

Tolerance on drilled hole diameter

	1.5mm - 3mm	= H9
over	3mm	= H11

Dimensions in mm Preferred sizes in **bold**

d_1 \varnothing	1,5	2	2,5	3	4	5	6	8	10	12	13	14	16	20	25
l	d_2^*														
4															
6	1,60														
8			2,60	3,10											
10		2,10			4,15	5,15									
12							6,15								
14				3,15											
16	1,63							8,20							
18		2,65			4,20	5,20									
20															
22				3,20			6,25		10,20						
24		2,15						8,25							
25															
26			2,70		4,25					12,25					
28						5,25		8,30							
30							6,30				13,25	14,25	16,25		
32				3,25										20,25	25,25
35									10,30	12,30	13,30	14,30	16,30		
36								8,35							
40														20,30	25,30
45					4,30				10,40						
50						5,30				12,40	13,40	14,40	16,40		
55														20,40	25,40
60							6,35	8,40							
65															
70									10,45						
75										12,50	13,50	14,50	16,50		
80														20,50	25,50
90								8,35							
100															
110															
120									10,40						
140										12,45	13,45	14,45	16,45		
160														20,45	25,45
180															

Typical Applications

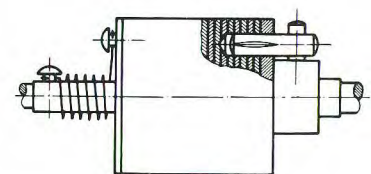
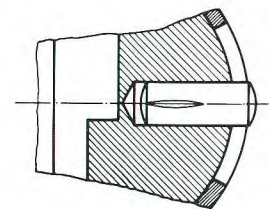
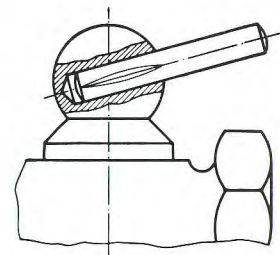
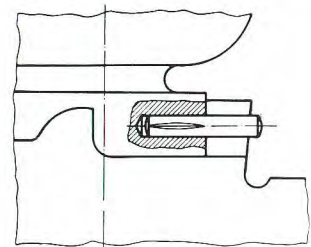

* The grooved diameter d_2 can only be measured with a ring gauge. Grooved diameters stated in the table apply only to material 9SMnPb28K - DIN 1651. The maximum grooved size cannot be achieved with some steels and some non-ferrous metals, particularly in the case of pins with short grooves.

Grooved Pin S5

Full length parallel grooves
plain spigot one end ...DIN 1470

Part No. 100...

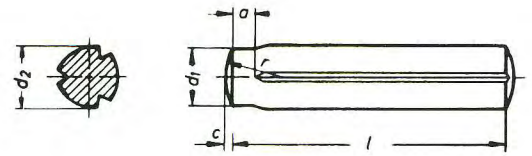

← Direction of Installation

For standard tolerance information see page 6

- d_1 Body diameter
- d_2 Grooved diameter
- l Body length
- $r_1 = d_1$
- c Height of dome
- a Spigot length

Tolerance on grooved diameter d_2

up to	2mm	+ 0.05
	2.5mm - 10mm	± 0.05
over	10mm	± 0.10

Tolerance on drilled hole diameter

under	1.5mm	= H8
	1.5mm - 3mm	= H9
over	3mm	= H11

Dimensions in mm Preferred sizes in **bold**

d_1 \varnothing	0,8	1	1,2	1,5	2	2,5	3	4	5	6	8	10	12	13	14	16	20	25	
a	0,5 ⁺¹		0,7 ⁺¹		1 ⁺¹		1,5 ⁺¹		2,0 ⁺¹		2,5 ⁺¹			3,0 ⁺¹					
l	d_2 *																		
4																			
6	0,83																		
8	1,05	1,25																	
10																			
12				1,60															
14																			
16																			
18				2,15	2,65														
20																			
22						3,20													
24																			
25																			
26						4,25	5,25												
28																			
30						6,30													
32																			
35								8,30											
36								10,35											
40										12,35	13,35								
45																			
50												14,35	16,40						
55														20,50			25,50		
60																			
65																			
70																			
75																			
80																			
90																			
100																			
110																			

Typical Applications

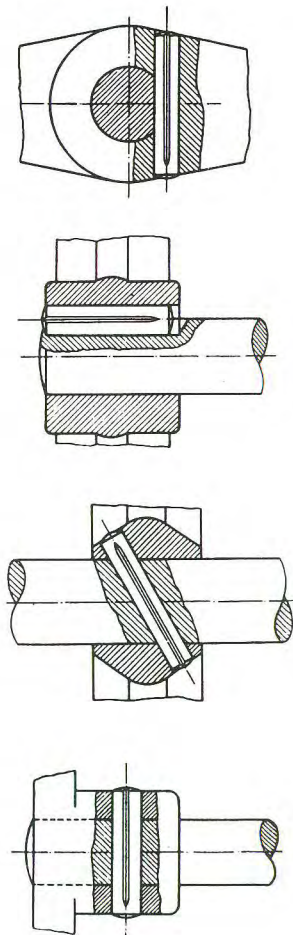

* The grooved diameter d_2 can only be measured with a ring gauge. Grooved diameters stated in the table apply only to material 9SMnPb28K - DIN 1651. The maximum grooved size cannot be achieved with some steels and some non-ferrous metals.

Grooved Pin S6

Half length tapering grooves
annular ring

Part No. 062...

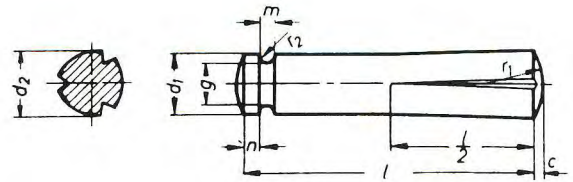

↔ Direction of Installation

For standard tolerance information see page 6

- d_1 Body diameter
- d_2 Grooved diameter
- l Body length
- $r_1 = d_1$
- $r_2 = m/2$
- c Height of dome
- m Width of annular groove
- n Width of head
- g Diameter of annular groove

- Tolerance on grooved diameter d_2**
- up to 2mm + 0.05
 - 2.5mm - 10mm ± 0.05
 - over 10mm ± 0.10

- Tolerance on drilled hole diameter**
- 2.0mm - 3mm = H9
 - over 3mm = H11

Dimensions in mm Preferred sizes in **bold**

\varnothing d_1	2	2,5	3	4	5	6	8	10	12	13	14	16	20	25
g	1,0	1,2	1,5	2,4	2,8	3,8	5,0	6,8	8,2	9,0	9,6	11,0	14,0	18,0
n = m	0,8	1,0	1,4	1,6	2,0	2,6	3,0	4,0	5,0	6,0				
l	d_2 *													
6														
8		2,65	3,20											
10				4,25	5,25									
12						6,25								
14			3,25				8,25							
16				4,30				10,30						
18	2,15													
20					5,30					13,30				
22		2,70					8,30	12,30						
24						6,30		10,35						
25			3,30							13,40				
26											14,40			
28				4,35					12,35					
30							8,35					16,50		
32														
35					5,35			10,40						
36			3,25						12,40	13,45	14,45		20,50	25,50
40						6,35						16,55		
45														
50				4,30										
55							8,40							
60					5,30									
65								10,45	12,45					
70						6,30				13,50	14,55			
75												16,60		
80							8,35							
90													20,60	25,60
100								10,40	12,40					
110														
120										13,45	14,45			
140								10,35				16,55		
160									12,35					
180														

Typical Applications

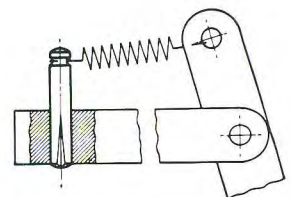
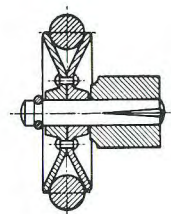
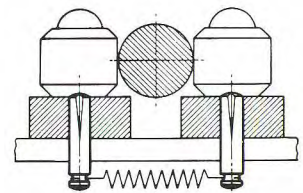
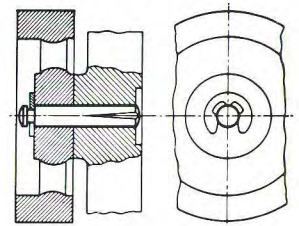

* The grooved diameter d_2 can only be measured with a ring gauge. Grooved diameters stated in the table apply only to material 9SMnPb28K - DIN 1651. The maximum grooved size cannot be achieved with some steels and some non-ferrous metals, particularly in the case of pins with short grooves.

Grooved Pin S7

Half length reverse tapering grooves
annular ring

Part No. 061...

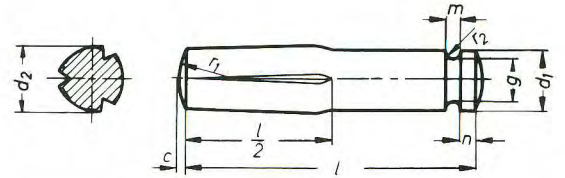

← Direction of Installation

For standard tolerance information see page 6

- d_1 Body diameter
- d_2 Grooved diameter
- l Body length
- $r_1 = d_1$
- $r_2 = m/2$
- c Height of dome
- m Width of annular groove
- n Width of head
- g Diameter of annular groove

Tolerance on grooved diameter d_2

- up to 2mm + 0.05
- 2.5mm - 10mm ± 0.05
- over 10mm ± 0.10

Tolerance on drilled hole diameter

- 2.0mm - 3mm = H9
- over 3mm = H11

Dimensions in mm Preferred sizes in **bold**

$\varnothing d_1$	2	2,5	3	4	5	6	8	10	12	13	14	16	20	25
g	1,0	1,2	1,5	2,4	2,8	3,8	5,0	6,8	8,2	9,0	9,6	11,0	14,0	18,0
n = m	0,8	1,0	1,4	1,6	2,0	2,6	3,0	4,0	5,0	6,0				
l	d_2 *													
6														
8		2,60	3,10											
10	2,10			4,15	5,15									
12						6,15								
14			3,15											
16							8,20							
18		2,65		4,20	5,20									
20														
22			3,20			6,25		10,20						
24	2,15						8,25							
25														
26		2,70		4,25					12,25					
28					5,25		8,30							
30						6,30				13,25	14,25	16,25		
32			3,25										20,25	25,25
35								10,30	12,30	13,30	14,30	16,30		
36							8,35							
40													20,30	25,30
45				4,30				10,40						
50					5,30				12,40	13,40	14,40	16,40		
55													20,40	25,40
60						6,35	8,40							
65														
70								10,45						
75									12,50	13,50	14,50	16,50		
80													20,50	25,50
90							8,35							
100														
110														
120								10,40						
140									12,45	13,45	14,45	16,45		
160													20,45	25,45
180														

Typical Applications

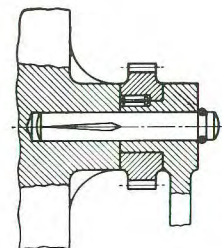
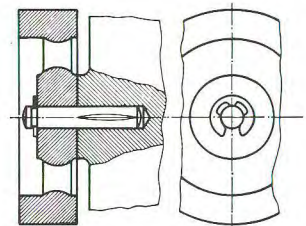
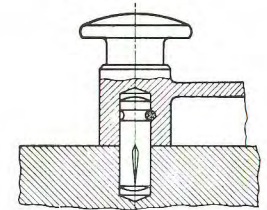

* The grooved diameter d_2 can only be measured with a ring gauge. Grooved diameters stated in the table apply only to material 9SMnPb28K - DIN 1651. The maximum grooved size cannot be achieved with some steels and some non-ferrous metals, particularly in the case of pins with short grooves.

Grooved Pin S8

Third length centre tapering grooves ...DIN 1475

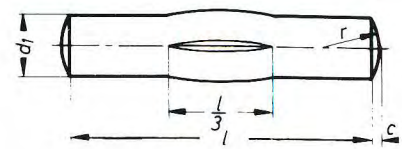

Direction of Installation

Part No. 058...

For standard tolerance information see page 6

- d_1 Body diameter
- d_2 Grooved diameter
- l Body length
- $r_1 = d_1$
- c Height of dome

Tolerance on grooved diameter d_2

up to	2mm	+ 0.05
	2.5mm - 10mm	± 0.05
over	10mm	± 0.10

Tolerance on drilled hole diameter

	1.5mm - 3mm	= H9
over	3mm	= H11

Dimensions in mm Preferred sizes in **bold**

\varnothing d_1	1,5	2	2,5	3	4	5	6	8	10	12	13	14	16	20	25
l	d_2^*														
8															
10	1,60														
12															
14			2,60	3,10											
16															
18	1,63	2,10			4,15	5,15									
20							6,15								
22				3,15											
24															
25			2,65		4,20			8,20							
26						5,20									
28		2,15													
30							6,25								
32				3,20											
35								8,25	10,20						
36					4,25					12,25					
40								8,30			13,25				
45						5,25						14,25	16,25		
50							6,30		10,30					20,25	25,25
55				4,30				8,35		12,30	13,30	14,30	16,30		
60					5,30									20,30	25,30
65									10,40						
70						6,35				12,40	13,40	14,40	16,40		
75														20,40	25,40
80							8,40								
90									10,45						
100															
110															
120										12,50	13,50	14,50	16,50		
140									10,40					20,50	25,50
160															
180															

Typical Applications

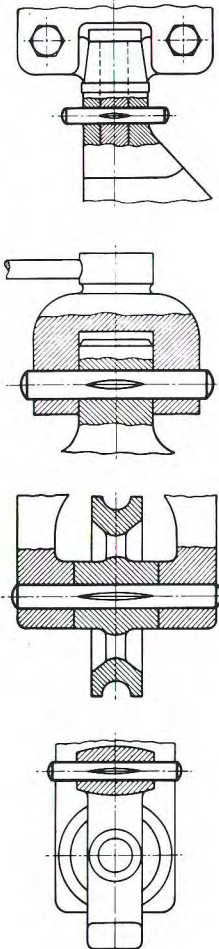

* The grooved diameter d_2 can only be measured with a ring gauge. Grooved diameters stated in the table apply only to material 9SMnPb28K - DIN 1651. The maximum grooved size cannot be achieved with some steels and some non-ferrous metals, particularly in the case of pins with short grooves.

Grooved Pin S9

Full length tapering grooves
annular ring

Part No. 101...

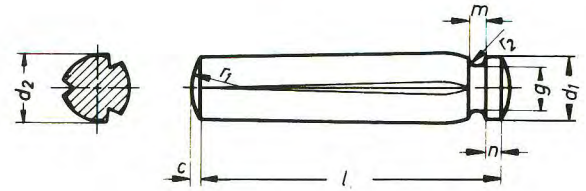

← Direction of Installation

For standard tolerance information see page 6

Tolerance on grooved diameter d_2

up to 2mm	+ 0.05
2.5mm - 10mm	± 0.05
over 10mm	± 0.10

Tolerance on drilled hole diameter

2.0mm - 3mm	= H9
over 3mm	= H11

d_1	Body diameter	c	Height of dome
d_2	Grooved diameter	m	Width of annular groove
l	Body length	n	Width of head
r_1	= d_1	g	Diameter of annular groove
r_2	= $m/2$		

Dimensions in mm Preferred sizes in **bold**

\varnothing d_1	2	2,5	3	4	5	6	8	10	12	13	14	16	20	25
g	1,0	1,2	1,5	2,4	2,8	3,8	5,0	6,8	8,2	9,0	9,6	11,0	14,0	18,0
n = m	0,8	1,0	1,4	1,6	2,0	2,6	3,0					4,0	5,0	6,0
l	d_2 *													
8	2,15													
10		2,65	3,20											
12			3,25											
14				4,25	5,25									
16	2,20					6,25								
18		2,70					8,30							
20			3,30	4,30	5,30									
22						6,30								
24								10,35	12,35					
25							8,35							
26	2,15			4,35	5,35									
28		2,65	3,25							13,40	14,40			
30												16,40	20,45	25,45
32						6,35		10,40	12,40					
35														
36			3,20	4,30			8,40			13,45	14,45	16,50		
40					5,30								20,55	25,55
45								10,45	12,45					
50						6,30				13,50	14,50	16,55		
55			4,25				8,35							
60				5,25										
65								10,40	12,40					
70						6,25								
75							8,30			13,45	14,45		20,60	25,60
80												16,60		
90								10,35	12,35					
100							8,25							
110										13,40	14,40			
120								10,30	12,30			16,55		

Typical Applications

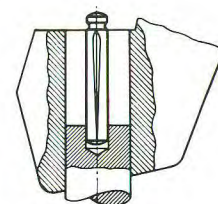
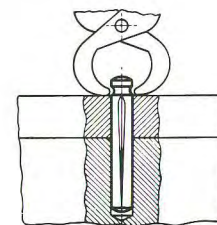
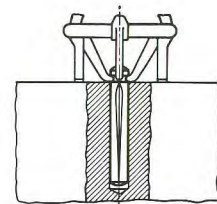
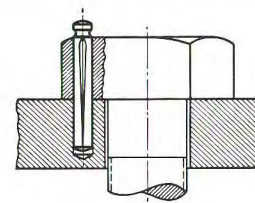

* The grooved diameter d_2 can only be measured with a ring gauge. Grooved diameters stated in the table apply only to material 9SMnPb28K - DIN 1651. The maximum grooved size cannot be achieved with some steels and some non-ferrous metals.

Grooved Pin S10

Third length centre tapering grooves
two annular rings

Part No. 102...

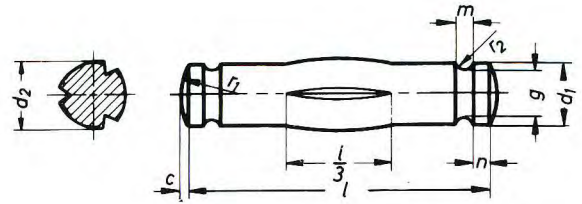

Direction of Installation

For standard tolerance information see page 6

- d_1 Body diameter
- d_2 Grooved diameter
- l Body length
- $r_1 = d_1$
- $r_2 = m/2$
- c Height of dome
- m Width of annular groove
- n Width of head
- g Diameter of annular groove

Tolerance on grooved diameter d_2

up to	2mm	+ 0.05
	2.5mm - 10mm	± 0.05
over	10mm	± 0.10

Tolerance on drilled hole diameter

	2.0mm - 3mm	= H9
over	3mm	= H11

Dimensions in mm Preferred sizes in bold

ϕ d_1	2	2,5	3	4	5	6	8	10	12	13	14	16	20	25
g	1,0	1,2	1,5	2,4	2,8	3,8	5,0	6,8	8,2	9,0	9,6	11,0	14,0	18,0
n = m	0,8	1,0	1,4	1,6	2,0	2,6	3,0	4,0	5,0	6,0				
l	d_2^*													
12														
14		2,60	3,10											
16														
18	2,10			4,15	5,15									
20						6,15								
22			3,15											
24														
25		2,65		4,20			8,20							
26					5,20									
28	2,15													
30						6,25								
32			3,20											
35							8,25	10,20						
36				4,25					12,25					
40							8,30			13,25				
45					5,25						14,25	16,25		
50						6,30		10,30					20,25	25,25
55				4,30			8,35		12,30	13,30	14,30	16,30		
60					5,30								20,30	25,30
65								10,40						
70						6,35			12,40	13,40	14,40	16,40		
75													20,40	25,40
80							8,40							
90								10,45						
100														
110														
120									12,50	13,50	14,50	16,50		
140									10,40				20,50	25,50
160														
180														

Typical Applications

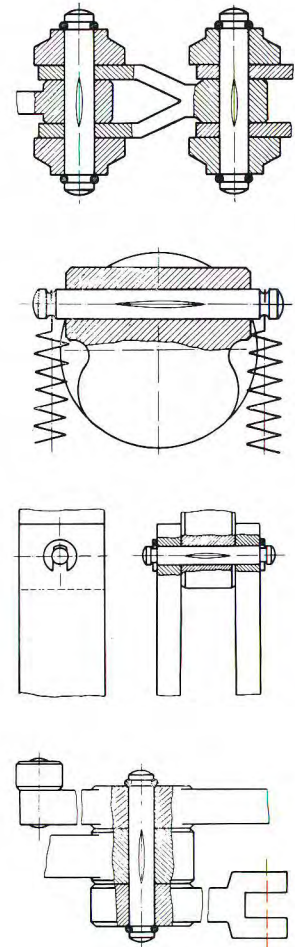

* The grooved diameter d_2 can only be measured with a ring gauge. Grooved diameters stated in the table apply only to material 9SMnPb28K - DIN 1651. The maximum grooved size cannot be achieved with some steels and some non-ferrous metals, particularly in the case of pins with short grooves.

Grooved Pin S11

Third length reverse tapering grooves

Part No. 103...

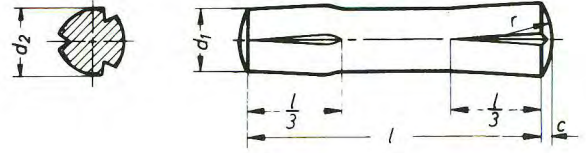

← Direction of Installation

For standard tolerance information see page 6

- d_1 Body diameter
- d_2 Grooved diameter
- l Body length
- $r_1 = d_1$
- c Height of dome

Tolerance on grooved diameter d_2

up to	2mm	+ 0.05
	2.5mm - 10mm	± 0.05
over	10mm	± 0.10

Tolerance on drilled hole diameter

	2.0mm - 3mm	= H9
over	3mm	= H11

Dimensions in mm Preferred sizes in **bold**

\varnothing d_1	2	2,5	3	4	5	6	8	10	12	13	14	16	20	25
l	d_2^*													
12														
14														
16		2,60	3,10											
18	2,10			4,15	5,15									
20														
22														
24			3,15			6,15								
25		2,65		4,20										
26					5,20									
28	2,15													
30						6,25	8,20							
32			3,20											
35							8,25							
36				4,25				10,20	12,20					
40														
45					5,25		8,30			13,25	14,25	16,25		
50						6,30		10,30	12,30				20,25	25,25
55				4,30			8,35			13,30	14,30	16,30		
60					5,30								20,30	25,30
65								10,40	12,40					
70						6,35				13,40	14,40	16,40		
75													20,40	25,40
80							8,40							
90								10,45	12,45					
100														
110														
120										13,50	14,50	16,50		
140								10,40					20,50	25,50
160									12,40					
180														

Typical Applications

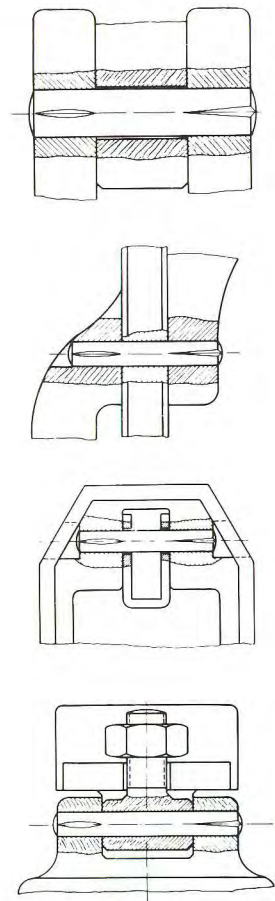

* The grooved diameter d_2 can only be measured with a ring gauge. Grooved diameters stated in the table apply only to material 9SMnPb28K - DIN 1651. The maximum grooved size cannot be achieved with some steels and some non-ferrous metals, particularly in the case of pins with short grooves.

Grooved Pin S12

Third length reverse tapering grooves

Part No. 060...

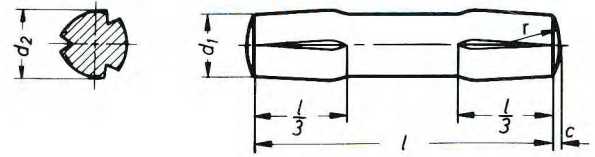

↔ Direction of Installation

For standard tolerance information see page 6

- d_1 Body diameter
- d_2 Grooved diameter
- l Body length
- $r_1 = d_1$
- c Height of dome

Tolerance on grooved diameter d_2

up to	2mm	+ 0.05
	2.5mm - 10mm	± 0.05
over	10mm	± 0.10

Tolerance on drilled hole diameter

	2.0mm - 3mm	= H9
over	3mm	= H11

Dimensions in mm Preferred sizes in **bold**

\varnothing d_1	2	2,5	3	4	5	6	8	10	12	13	14	16	20	25	
l	d_2^*														
12															
14															
16		2,60	3,10												
18	2,10			4,15	5,15										
20															
22															
24			3,15			6,15									
25		2,65		4,20											
26					5,20										
28	2,15														
30						6,25	8,20								
32			3,20												
35							8,25								
36				4,25				10,20	12,20						
40															
45					5,25		8,30			13,25	14,25	16,25			
50						6,30		10,30	12,30				20,25	25,25	
55				4,30			8,35			13,30	14,30	16,30			
60					5,30								20,30	25,30	
65								10,40	12,40						
70						6,35				13,40	14,40	16,40			
75													20,40	25,40	
80							8,40								
90								10,45	12,45						
100															
110															
120										13,50	14,50	16,50			
140								10,40					20,50	25,50	
160									12,40						
180															

Typical Applications

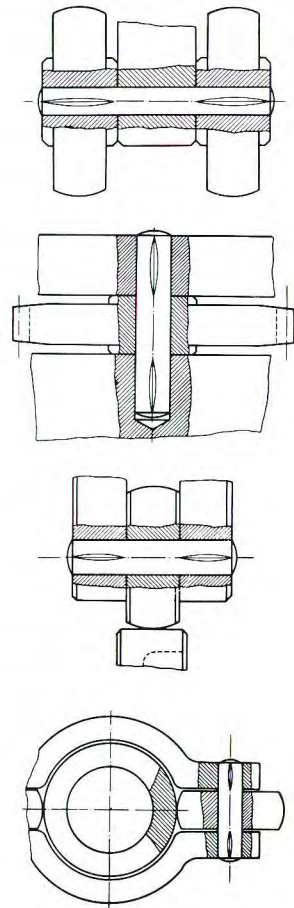

* The grooved diameter d_2 can only be measured with a ring gauge. Grooved diameters stated in the table apply only to material 9SMnPb28K - DIN 1651. The maximum grooved size cannot be achieved with some steels and some non-ferrous metals, particularly in the case of pins with short grooves.

Grooved Pin S24

Half length parallel grooves

Part No. 104...

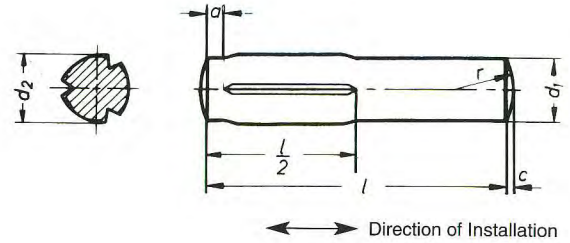

For standard tolerance information see page 6

- d_1 Body diameter
- d_2 Grooved diameter
- l Body length
- $r_1 = d_1$
- c Height of dome
- a Spigot length

Tolerance on grooved diameter d_2

up to	2mm	+ 0.05
	2.5mm - 10mm	± 0.05
over	10mm	± 0.10

Tolerance on drilled hole diameter

under	1.5mm	= H8
	1.5mm - 3mm	= H9
over	3mm	= H11

Dimensions in mm Preferred sizes in **bold**

d_1 \varnothing	0,8	1	1,2	1,5	2	2,5	3	4	5	6	8	10	12	13	14	16	20	25				
a	0,5 ⁺¹		0,7 ⁺¹		1,0 ⁺¹		1,5 ⁺¹		2,0 ⁺¹		2,5 ⁺¹				3,0 ⁺¹							
l	d_2^*																					
4																						
6																						
8																				0,83		
10																						
12																				1,05	1,25	1,60
14																						
16																						
18																				2,15	2,65	
20																						
22																				3,20		
24																						
25																						
26																				4,25	5,25	
28																						
30																				6,30		
32																						
35																				8,30		
36																						
40																						
45	10,35	12,35																				
50	13,35		14,35																			
55																						
60	16,40	20,50	25,50																			
65																						
70																						
75																						
80																						
90																						
100																						
110																						
120																						
140																						
160																						

Typical Applications

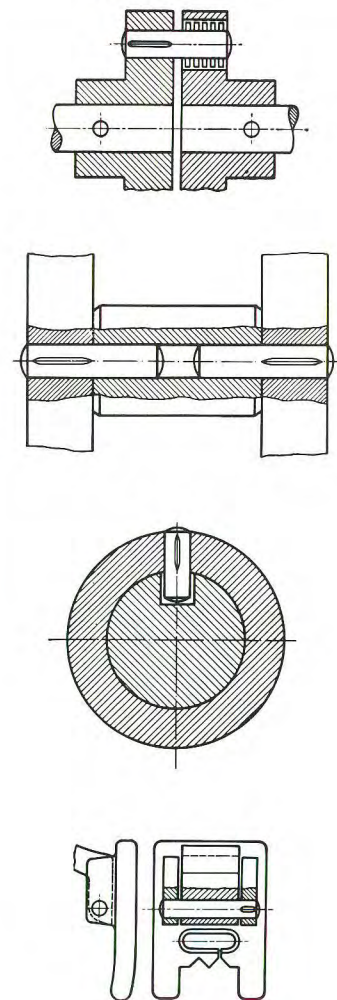

* The grooved diameter d_2 can only be measured with a ring gauge. Grooved diameters stated in the table apply only to material 9SMnPb28K - DIN 1651. The maximum grooved size cannot be achieved with some steels and some non-ferrous metals.

Grooved Pin S30

Full length parallel grooves
double chamfer

Part No. 105...

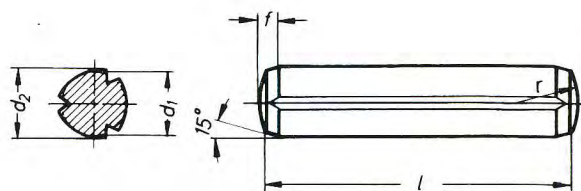

Direction of Installation

For standard tolerance information see page 6

- d_1 Body diameter
- d_2 Grooved diameter
- l Body length
- $r_1 = d_1$
- f Width of chamfer

Tolerance on grooved diameter d_2

up to	2mm	+ 0.05
	2.5mm - 10mm	\pm 0.05
over	10mm	\pm 0.10

Tolerance on drilled hole diameter

under	1.5mm	= H8
	1.5mm - 3mm	= H9
over	3mm	= H11

Dimensions in mm Preferred sizes in **bold**

\varnothing d_1	0,8	1	1,2	1,5	2	2,5	3	4	5	6	8	10	12	13	14	16	20	25	
$f \approx$	0,55	0,57	0,6	0,8	0,9	1,2	1,3	1,8	2	2,5	2,8	3,5	3,7	3,8	4	4,3	5,2	6	
l	d_2^*																		
4																			
5																			
6	0,83	1,05																	
8			1,25																
10				1,60															
12																			
14					2,15	2,65													
16																			
18																			
20							3,20												
22																			
24																			
25								4,25	5,25										
26																			
28										6,30									
30																			
32											8,30								
35																			
36												10,35							
40													12,35						
45														13,35	14,35				
50																16,40			
55																			
60																	20,50	25,50	
65																			
70																			
75																			
80																			
90																			
100																			
110																			
120																			

Typical Applications

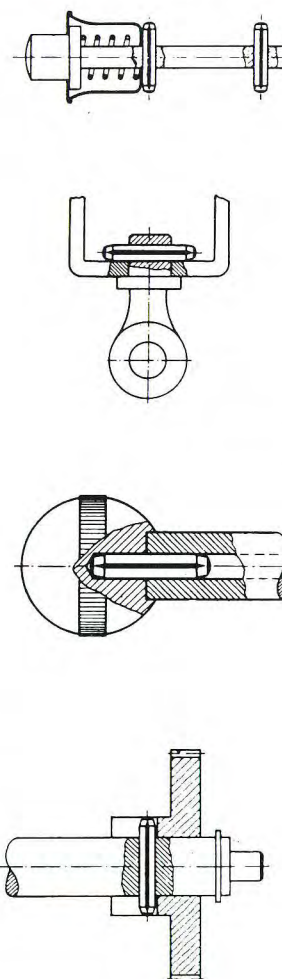

* The grooved diameter d_2 can only be measured with a ring gauge. Grooved diameters stated in the table apply only to material 9SMnPb28K - DIN 1651. The maximum grooved size cannot be achieved with some steels and some non-ferrous metals.

Grooved Pin S50

Full length parallel grooves
double spigot

Part No. 106...

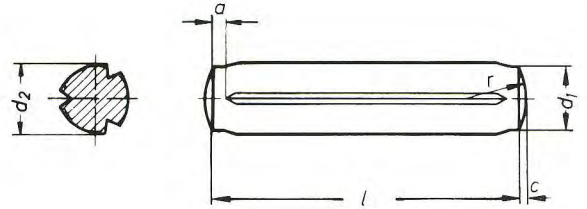

↔ Direction of Installation

For standard tolerance information see page 6

- d_1 Body diameter
- d_2 Grooved diameter
- l Body length
- $r_1 = d_1$
- c Height of dome
- a Spigot length

Tolerance on grooved diameter d_2

up to 2mm	+ 0.05
2.5mm - 10mm	± 0.05
over 10mm	± 0.10

Tolerance on drilled hole diameter

under 1.5mm	= H8
1.5mm - 3mm	= H9
over 3mm	= H11

Dimensions in mm Preferred sizes in **bold**

d_1 \varnothing	0,8	1	1,2	1,5	2	2,5	3	4	5	6	8	10	12	13	14	16	20	25	
a	0,5 ⁺		0,7 ⁺			1 ⁺		1,5 ⁺		2,0 ⁺		2,5 ⁺			3,0 ⁺				
l	d_2 *																		
4																			
5																			
6	0,83																		
8	1,05 1,25 1,60																		
10																			
12																			
14																			
16																			
18	2,15 2,65																		
20																			
22																			
24																			
25																			
26																			
28																			
30																			
32																			
35																			
36																			
40																			
45																			
50																			
55																			
60																			
65																			
70																			
75																			
80																			
90																			
100																			
110																			

Typical Applications

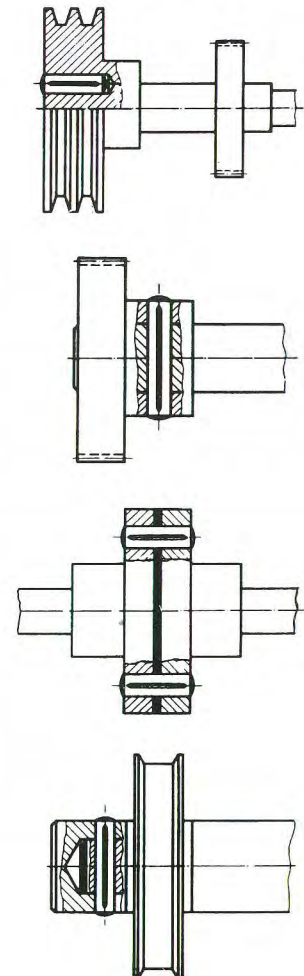

* The grooved diameter d_2 can only be measured with a ring gauge. Grooved diameters stated in the table apply only to material 9SMnPb28K - DIN 1651. The maximum grooved size cannot be achieved with some steels and some non-ferrous metals.

Grooved Pin S80

Third length parallel grooves

Part No. 108...

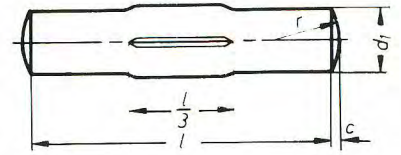

Direction of Installation

For standard tolerance information see page 6

- d_1 Body diameter
- d_2 Grooved diameter
- l Body length
- $r_1 = d_1$
- c Height of dome

Tolerance on grooved diameter d_2

up to 2mm	+ 0.05
2.5mm - 10mm	± 0.05
over 10mm	± 0.10

Tolerance on drilled hole diameter

under 1.5mm	= H8
1.5mm - 3mm	= H9
over 3mm	= H11

Dimensions in mm Preferred sizes in **bold**

$\varnothing d_1$	0,8	1	1,2	1,5	2	2,5	3	4	5	6	8	10	12	13	14	16	20	25	
l	d_2^*																		
6																			
8																			
10																			
12																			
14																			
16																			
18																			
20																			
22																			
24																			
25																			
26																			
28																			
30																			
32																			
35																			
36																			
40																			
45																			
50																			
55																			
60																			
65																			
70																			
75																			
80																			
90																			
100																			
110																			
120																			
140																			
160																			
180																			

Typical Applications

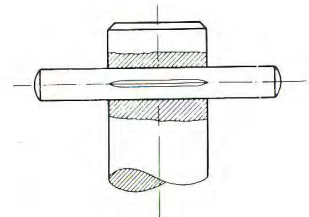
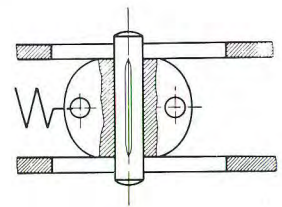
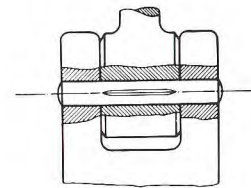
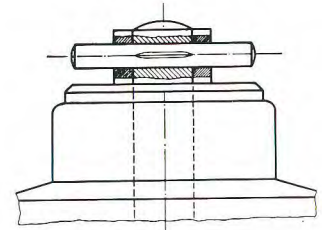

* The grooved diameter d_2 can only be measured with a ring gauge. Grooved diameters stated in the table apply only to material 9SMnPb28K - DIN 1651. The maximum grooved size cannot be achieved with some steels and some non-ferrous metals.

Grooved Pin S112

Third length double parallel grooves

Part No. 109...

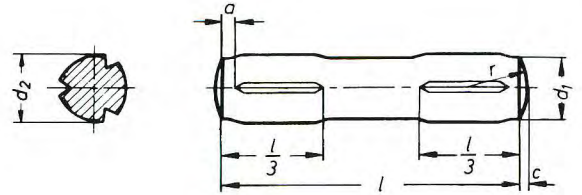

For standard tolerance information see page 6

- d_1 Body diameter
- d_2 Grooved diameter
- l Body length
- $r_1 = d_1$
- c Height of dome
- a Spigot length

Tolerance on grooved diameter d_2

up to 2mm	+ 0.05
2.5mm - 10mm	± 0.05
over 10mm	± 0.10

Tolerance on drilled hole diameter

2.0mm - 3mm	= H9
over 3mm	= H11

Dimensions in mm Preferred sizes in **bold**

\varnothing d_1	2	2,5	3	4	5	6	8	10	12	13	14	16	20	25
a	0,7 ⁺	1,0 ⁺		1,5 ⁺		2,0 ⁺			2,5 ⁺					3,0 ⁺
l	d_2^*													
12														
14														
16														
18														
20														
22	2,15	2,65												
24														
25			3,20											
26														
28														
30				4,25	5,25									
32														
35														
36														
40						6,30								
45														
50														
55							8,30							
60														
65								10,35	12,35					
70										13,35	14,35	16,40	20,50	25,50
75														
80														
90														
100														
110														
120														

Typical Applications

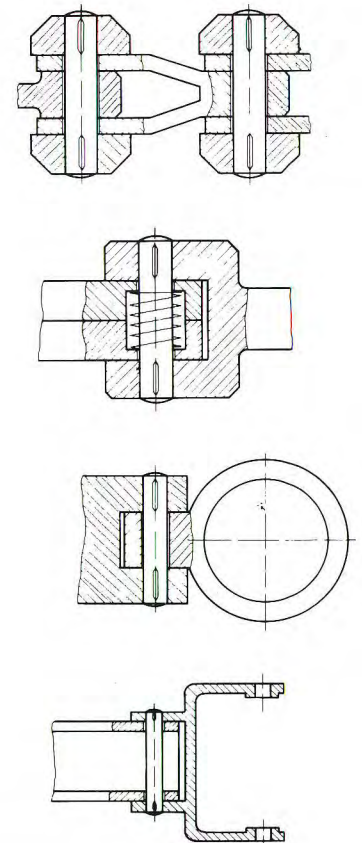

* The grooved diameter d_2 can only be measured with a ring gauge. Grooved diameters stated in the table apply only to material 9SMnPb28K - DIN 1651. The maximum grooved size cannot be achieved with some steels and some non-ferrous metals.

Headed Grooved Pin N4

Round Head ...DIN 1476

Part No. 063...

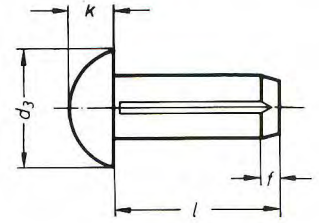

For standard tolerance information see page 6

- d_2 Body diameter
- d_3 Grooved diameter
- l Body length
- k Head thickness
- f Width of chamfer

Tolerance on grooved diameter d_2

up to	2mm	+ 0.05
	2.5mm - 10mm	± 0.05
over	10mm	± 0.10

Tolerance on drilled hole diameter

	1.4mm - 3mm	= H9
over	3mm	= H11

Dimensions in mm Preferred sizes in **bold**

d_1 \emptyset	1,4	1,6	1,7	2	2,3	2,5	2,6	3	4	5	6	7	8	10	12	16	20	
d_3	2,4	2,8	3	3,5	4	4,4	4,5	5,2	7	8,8	10,5	12,2	14	16	19	25	32	
k	0,8	1	1	1,2	1,4	1,5	1,6	1,8	2,4	3	3,6	4,2	4,8	6,5	7,5	10	13	
$f \approx$	0,5			0,7				1,0	1,5	2,0			2,5		3,0			
l	d_2 *																	
3	-																	
4	-																	
5	1,50	1,70	1,80	-														
6	-			2,15	2,45	2,70	2,80	-										
7	-							-										
8	-							3,20	-									
10	-							-										
12	-							4,25		-								
15	-							5,25			-							
16	-							6,30				-						
18	-							7,30					-					
20	-							8,30						-				
22	-							10,35							-			
25	-							12,35								-		
28	-							16,40										
30	-							20,50										
32	-																	
35	-																	
38	-																	
40	-																	

Typical Applications

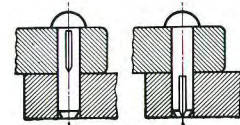
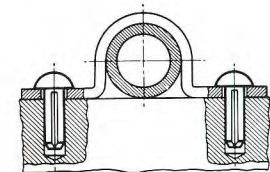
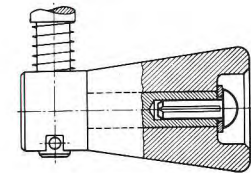
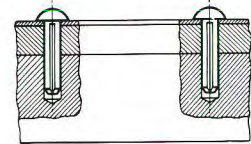

* The grooved diameter d_3 can only be measured with a ring gauge. Grooved diameters stated in the table apply only to material QSt 36-3 - DIN 17111. The maximum grooved size cannot be achieved with some steels and some non-ferrous metals.

Headed Grooved Pin N5

Countersunk Head ...DIN 1477

Part No. 064...

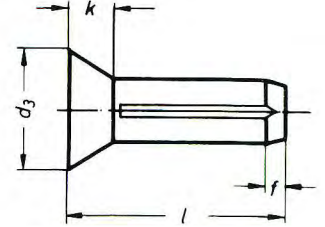
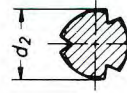

For standard tolerance information see page 6

Tolerance on grooved diameter d_2

- d_2 Grooved diameter
- d_3 Head diameter
- l Body length
- k Head thickness
- f Width of chamfer

up to	2mm	+ 0.05
	2.5mm - 10mm	± 0.05
over	10mm	± 0.10

Tolerance on drilled hole diameter

	1.4mm - 3mm	= H9
over	3mm	= H11

Dimensions in mm Preferred sizes in **bold**

\varnothing d_1	1,4	1,6	1,7	2	2,3	2,5	2,6	3	4	5	6	7	8	10	12	16	20	
d_3	2,5	2,8	3	3,5	4	4,4	4,5	5,2	7	8,8	10,5	12,2	14	16	19	26	31,5	
k	0,7	0,8	0,9	1	1,2	1,2	1,3	1,4	2	2,5	3	3,5	3,9	4	4,6	6,5	9,5	
$f \approx$	0,5			0,7				1,0	1,5			2,0			2,5		3,0	
	75°																60°	
l	d_2^*																	
3																		
4																		
5	1,50	1,70	1,80															
6				2,15	2,45	2,70	2,80											
7																		
8									3,20									
10											4,25							
12													5,25					
15																		
16																	6,30	
18																		7,30
20																		
22																		
25																		
28																		
30																		
32																		
35																		
38																		
40																		

Typical Applications

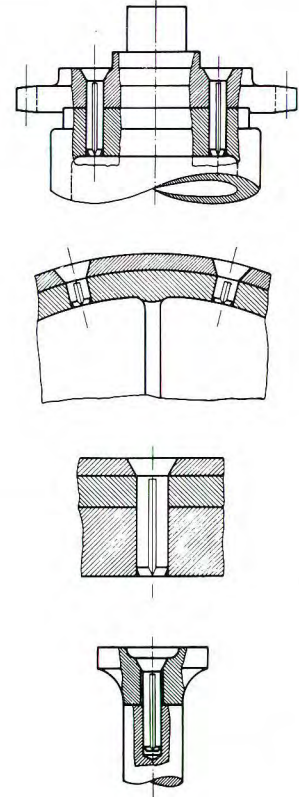

* The grooved diameter d_2 can only be measured with a ring gauge. Grooved diameters stated in the table apply only to material QSt 36-3 - DIN 17111. The maximum grooved size cannot be achieved with some steels and some non-ferrous metals.

Headed Grooved Pin N7

Round Head - Plain shank

Part No. 110...

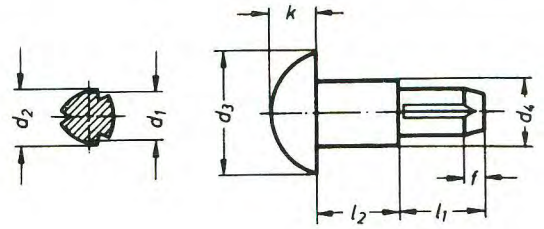

For standard tolerance information see page 6

d_1	Ungrooved diameter	k	Head thickness
d_2	Grooved diameter	l_1	Grooved length
d_3	Head diameter	l_2	Shank length
d_4	Shank diameter		
f	Width of chamfer		

Tolerance on grooved diameter d_2

up to	2mm	+ 0.05
	2.5mm - 10mm	± 0.05
over	10mm	± 0.10

Tolerance on drilled hole diameter

	1.4mm - 3mm	= H9
over	3mm	= H11

Typical Applications

Headed Grooved Pins 110 are only made to special order, and since the possible variations are significant it is not normal to have ex-stock sizes. In order to provide a quotation the following information should be given.

- Diameter d_4 _____
- Total pin length under the head i.e. $l_1 + l_2$ _____
- Nominal diameter of grooved portion d_2 _____
- Length of grooved portion l_1 _____
- * Head form _____
- * Head diameter d_3 _____
- * Head thickness k _____

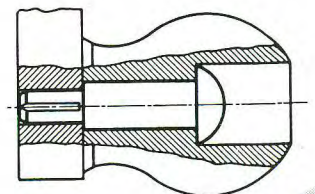
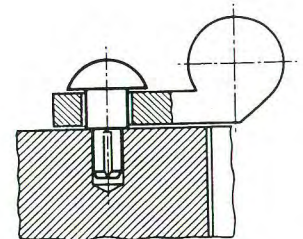
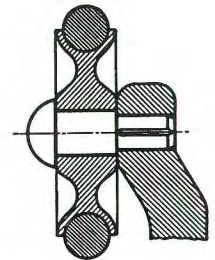
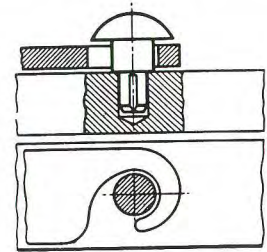

This data sheet has been designed to be photocopied and returned for quotation purposes. Precise details of the Application of the Pin will assist our Application Engineers.

* Where possible use Part No. 063 head standards

Blind Drive Pin Rivet B60

Round Head ...DIN 660

Part No. 019... (Steel)

Part No. 020... (Aluminium)

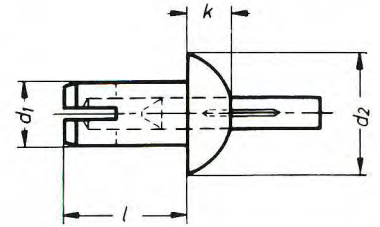

Tolerance on drilled hole diameter = H11

For material specification see page 7

Special materials available to order.

- d₁ Body diameter
- d₂ Head diameter
- l Body Length
- k Head thickness
- S Clamping length

Dimensions in mm S = Approximate clamping length

∅ d ₁	3	4	5	6	8
∅ d ₂	5,2	7,0	8,8	10,5	14,0
k	1,8	2,4	3,0	3,6	4,8
l	S				
5	2 - 3				
6	3 - 4	3 - 4			
7	4 - 5	4 - 5			
8	5 - 6	5 - 6			
8,5			5 - 6		
9		6 - 7			
9,5			6 - 7		
10		7 - 8			
10,5			7 - 8	7 - 8	
11		8 - 9			
11,5			8 - 9	8 - 9	
12		9 - 10			
12,5			9 - 10	9 - 10	
13					9 - 10
13,5			10 - 11	10 - 11	
14					10 - 11
14,5			11 - 12	11 - 12	
15					11 - 12
15,5			12 - 13	12 - 13	
16					12 - 13
16,5			13 - 14	13 - 14	
17					13 - 14
17,5				14 - 15	
18					14 - 15
18,5				15 - 16	
19					15 - 16
20					16 - 17
21					17 - 18
22					18 - 19
23					19 - 20

Typical Applications

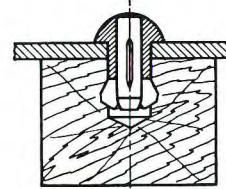
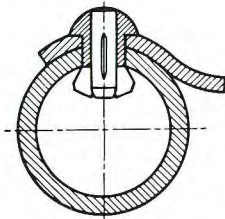
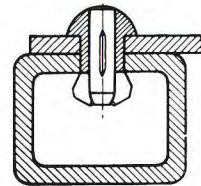

NOTE

3mm diameter rivets are available with a single expansion slot. Above 3mm the rivet body has two slots for easier expansion.

Blind Drive Pin Rivet B61

Countersunk Head ...DIN 661

Part No. 021... (Aluminium)

Part No. 022... (Steel)

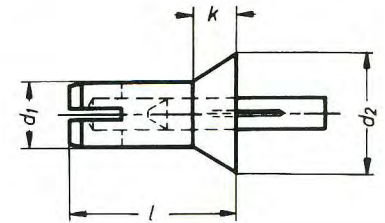

Tolerance on drilled hole diameter = H11

For material specification see page 7

Special materials available to order.

- d₁ Body diameter
- d₂ Head diameter
- l Body Length
- k Head thickness
- S Clamping length

Dimensions in mm S = Approximate clamping length

∅ d ₁	3	4	5	6	8
∅ d ₂	5,2	7,0	8,8	10,5	14,0
k	1,5	2,0	2,5	3,0	4,0
l	S				
5	2 - 3				
6	3 - 4	3 - 4			
7	4 - 5	4 - 5			
8	5 - 6	5 - 6			
8,5			5 - 6		
9		6 - 7			
9,5			6 - 7		
10		7 - 8			
10,5			7 - 8	7 - 8	
11		8 - 9			
11,5			8 - 9	8 - 9	
12		9 - 10			
12,5			9 - 10	9 - 10	
13					9 - 10
13,5			10 - 11	10 - 11	
14					10 - 11
14,5			11 - 12	11 - 12	
15					11 - 12
15,5			12 - 13	12 - 13	
16					12 - 13
16,5			13 - 14	13 - 14	
17					13 - 14
17,5				14 - 15	
18					14 - 15
18,5				15 - 16	
19					15 - 16
20					16 - 17
21					17 - 18
22					18 - 19
23					19 - 20

Typical Applications

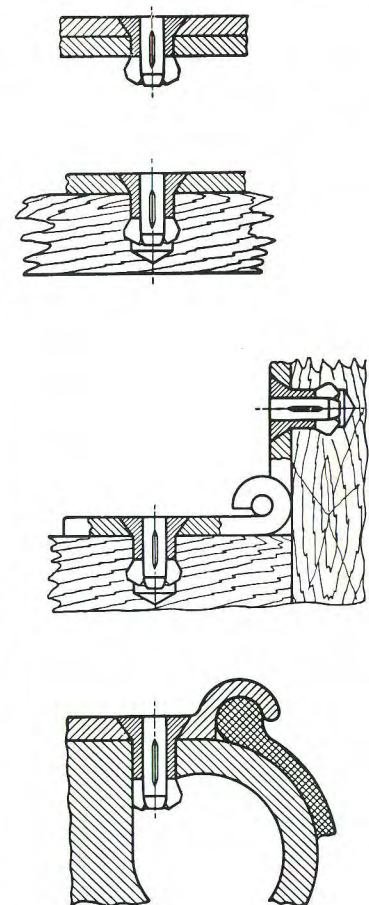

NOTE

3mm diameter rivets are available with a single expansion slot. Above 3mm the rivet body has two slots for easier expansion.

Blind Drive Pin Rivet B74

Flat-round Head ...DIN 674

Part No. 111... (Aluminium)

Part No. 112... (Steel)

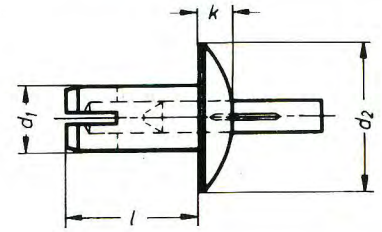

Tolerance on drilled hole diameter = H11

For material specification see page 7

Special materials available to order.

- d₁ Body diameter
- d₂ Head diameter
- l Body Length
- k Head thickness
- S Clamping length

Dimensions in mm S = Approximate clamping length

∅	d ₁	3	4	5	6	8
∅	d ₂	6,8	9,0	11,2	13,5	18,0
	k	1,5	2,0	2,5	3,0	4,0
	l	S				
5		2 - 3				
6		3 - 4	3 - 4			
7		4 - 5	4 - 5			
8		5 - 6	5 - 6			
8,5				5 - 6		
9			6 - 7			
9,5				6 - 7		
10			7 - 8			
10,5				7 - 8	7 - 8	
11			8 - 9			
11,5				8 - 9	8 - 9	
12			9 - 10			
12,5				9 - 10	9 - 10	
13						9 - 10
13,5				10 - 11	10 - 11	
14						10 - 11
14,5				11 - 12	11 - 12	
15						11 - 12
15,5				12 - 13	12 - 13	
16						12 - 13
16,5				13 - 14	13 - 14	
17						13 - 14
17,5					14 - 15	
18						14 - 15
18,5					15 - 16	
19						15 - 16
20						16 - 17
21						17 - 18
22						18 - 19
23						19 - 20

Typical Applications

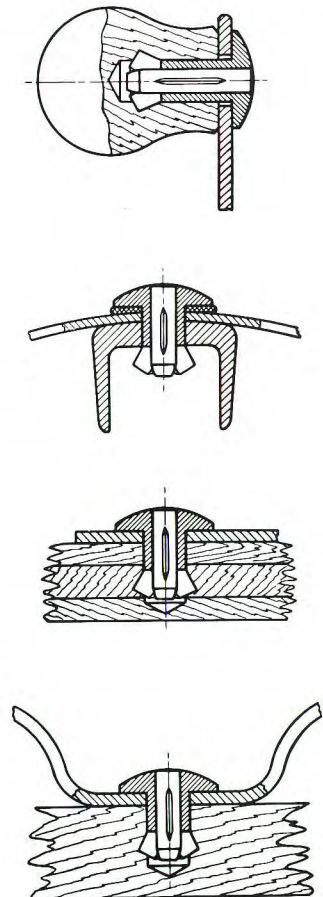

NOTE

3mm diameter rivets are available with a single expansion slot. Above 3mm the rivet body has two slots for easier expansion.

Grooved Pin S67

Half length parallel grooves
annular ring ...DIN 1469

Part No. 107...

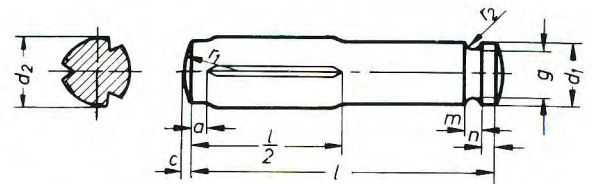

Direction of Installation

For standard tolerance information see page 6

- d_1 Body diameter
- d_2 Grooved diameter
- l Body length
- $r_1 = d_1$
- $r_2 = \frac{m}{2}$ Form C only
- c Height of dome
- m Width of annular groove
- n Width of head
- g Diameter of annular groove
- a Spigot length

Tolerance on grooved diameter d_2
up to 2mm + 0.05

2.5mm - 10mm ± 0.05

over 10mm ± 0.10

Tolerance on drilled hole diameter

2.0mm - 3mm = H9

over 3mm = H11

Dimensions in mm Preferred sizes in bold

Form A	with annular groove for circlips as per DIN 471
Form B	with annular groove for locking washers as per DIN 6799
Form C	with rounded groove for tension springs

Typical Applications

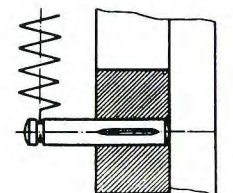
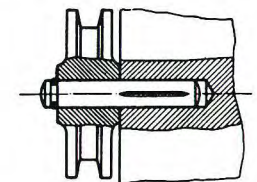
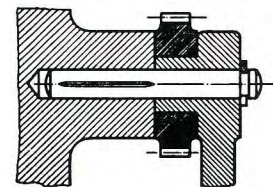
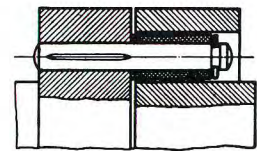

	d_1	2	2,5	3	4	5	6	8	10	12	13	14	16	20	25
Form A	g ^{H11}	-	-	2,8	3,8	4,8	5,7	7,6	9,6	11,5	12,4	13,4	15,2	19	23,9
	m ^{H13}	-	-	0,5	0,5	0,7	0,8	0,9	1,1	1,1	1,1	1,1	1,1	1,3	1,3
	n	-	-	1	1,4	1,6	1,6	2	2,6	3	3	3	4	5	6
Form B	g ^{H11}	1,5	1,9	2,3	3,2	4	5	7	9	10	12	12	15	19	24
	m	0,44	0,54	0,64	0,64	0,74	0,74	0,94	1,15	1,25	1,35	1,35	1,55	1,80	2,05
		+0,02				+0,03									+0,06
	n	0,8	0,8	1	1,4	1,6	1,6	2	2,6	3	3	3	4	5	6
Form C	g	1	1,2	1,5	2,4	2,8	3,8	5	6,8	8,2	9	9,6	11	14	18
	m ^{±1/2IT14}	0,8	0,8	1	1,4	1,6	1,6	2	2,6	3	3	3	4	5	6
	n	0,8	0,8	1	1,4	1,6	1,6	2	2,6	3	3	3	4	5	6
r_2		0,4	0,4	0,5	0,7	0,8	0,8	1	1,3	1,5	1,5	1,5	2	2,5	3
a	+1	0,7	1	1	1,5	1,5	2	2	2,5	2,5	2,5	2,5	2,5	3	3

Form C is the standard form unless otherwise specified

All other dimensions and grooved diameter d_2 as for Grooved Pin Part No. 104 (see page 20).

Non standard items can be produced to special order.